

Article number: 0102082

Description: Retaining ring J70 DIN472  
Spring steel

## Measures

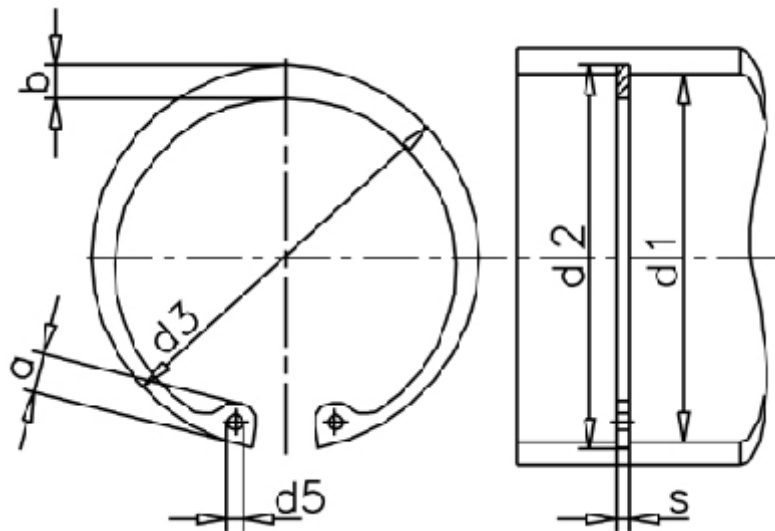

a max	= 7.8	FN kN	= 56.20	t	= 1.50
AN mm <sup>2</sup>	= 337.0	FRg kN	= 21.0	tol	= +0,30
b	= 6.2	FR kN	= 119.0	tol	= +1,10-0,46
d1	= 70	g	= 2.5	tol	= -0.07
d2	= 73.0	K kN-mm	= 218.0	Tong	= ZGJ-3
d3	= 74.50	m min	= 2.65	Weight kg/1000	= 16.50
d5 min	= 3.0	Nominal drive	= 4.5		
Description = J 70		s	= 2.50		